

CX12 S2 1150X520 PLUS

SMALL SIZE, GREAT MANOEUVRABILITY



CX12

The CX12 electric pallet truck is suitable for carrying loads on smooth or paved surfaces. Its small size and turning radius make it the ideal tool to work with in confined spaces, such as lorries or narrow aisles.



MANOEUVRABILITY

Thanks to the B1 width, which is equal to the fork gauge, and the L2 measurement of 360 mm, the CX12 electric pallet truck is the ideal tool for the handling of pallets on lorries, in supermarket aisles and any application where space is limited. This machine is the best configuration in its category thanks to the frame width, in-service weight and turning radius, thus guaranteeing great manoeuvrability and compactness.



STEERING WHEEL AND CONTROLS

- Ergonomic tiller
- Luminous indicator for battery state control.
- Butterfly valves for traction control.
- Safety pushbutton with warning buzzer.
- Forks way up/down control positioned on both sides of the handle (only on CX14).
- Hour counter in the Plus and Gel versions (only on CX14).
- “Tortoise” pushbutton for slow motion, which allows for the carrying out of operations with the tiller in vertical position.



ROLLERS

Standard configuration provided with single polyurethane rollers. Available tandem rollers as optional.



Description

1.1 Manufacturer			LIFTER
Lift			ELECTRIC
1.3 Drive			ELECTRIC
1.4 Operator type			Pedestrian
1.5 Load capacity	Q	Kg	1200
1.6 Load centre distance	c	mm	600
1.8 Load axle to end forks	x	mm	886
1.9 Wheel base	y	mm	1119

Weights

2.1 Service weight (battery included)		Kg	165
2.2 Axle load, laden rear		Kg	924
2.2 Axle load, laden front		Kg	441
2.3 Axle load, unladen front		Kg	134
2.3 Axle load, unladen rear		Kg	31

Tyres/Chassis

3.1 Tyres: front wheels			RUBBER
3.1 Tyres: stabilizers wheels - Front			POLY.I.
3.1 Tyres: rear wheels			NYLON
3.2 Tyre size: Steering wheels - Width		mm	50
3.2 Tyre size: Steering wheels - Diameter		mm	186
3.3 Tyre size: Load rollers - Diameter		mm	82
3.3 Tyre size: Load rollers - Width		mm	82
3.4 Tyre size: stabilizers wheels front - Diameter		mm	75
3.4 Tyre size: stabilizers wheels front - Width		mm	32
3.5 Tyre size: rear wheels - Q.ty (X=driven)		nr	2
3.5 Tyre size: front wheels - Q.ty (X=driven)		nr	1x
3.6 Tread, front	b10	mm	369
3.7 Tread, rear	b11	mm	371

Dimensions

4.4 Lift height	h3	mm	115
4.9 Height of tiller in drive position max	h14	mm	1345
4.9 Height of tiller in drive position min	h14	mm	885
4.15 Height, lowered	h13	mm	85
4.19 Overall length	l1	mm	1510
4.20 Length to face of forks	l2	mm	360
4.21 Overall width	b1	mm	520
4.22 Fork dimensions - Thickness	s	mm	55
4.22 Fork dimensions - Width	e	mm	150
4.22 Fork dimensions - Length	l	mm	1150
4.25 Distance between fork arms	b5	mm	520
4.32 Ground clearance, centre of wheelbase	m2	mm	30
4.34 Aisle width	Ast	mm	1782
4.35 Turning radius	Wa	mm	1268

Performance data

5.1 Travel speed laden	Km/h	4.3
5.1 Travel speed unladen	Km/h	4.8
5.2 Lifting speed laden	m/s	0.03
5.2 Lifting speed unladen	m/s	0.04
5.3 Lowering speed laden	m/s	0.05
5.3 Lowering speed unladen	m/s	0.02
5.8 Max gradeability laden	%	10
5.8 Max gradeability unladen	%	25
5.10 Service brake		Electric

Electric motors

6.1 Drive motor power	kW	0.35
6.2 Lift motor power	kW	0.4
Battery Type	Tipo	TRACTION
6.4 Battery voltage	V	24
6.4 Battery capacity, Min	Ah	45
6.4 Battery capacity, Max	Ah	45
6.5 Battery weight, Min	Kg	25
6.5 Battery weight, Max	Kg	40
6.6 Energy consumption according to VDI cycle	kWh/h	0.28
8.4 Sound level at driver's ear	dB(A)	67

*Integrated battery and battery charger

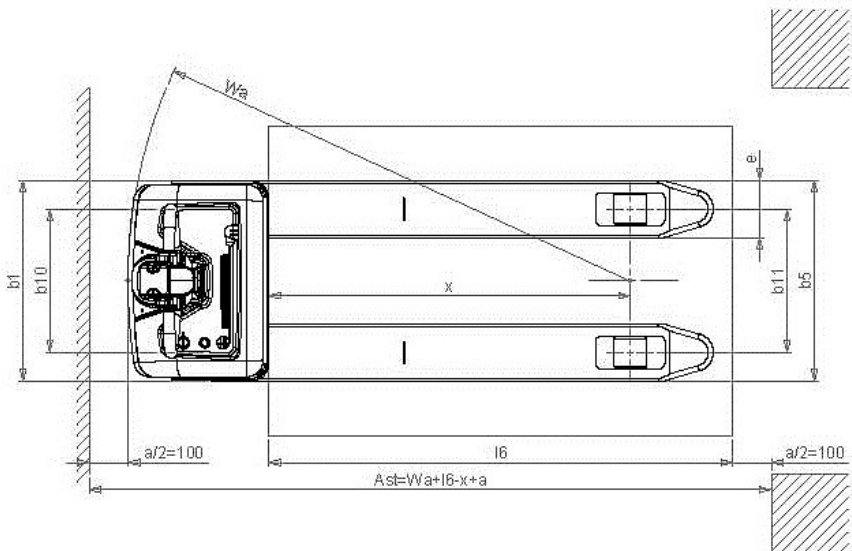
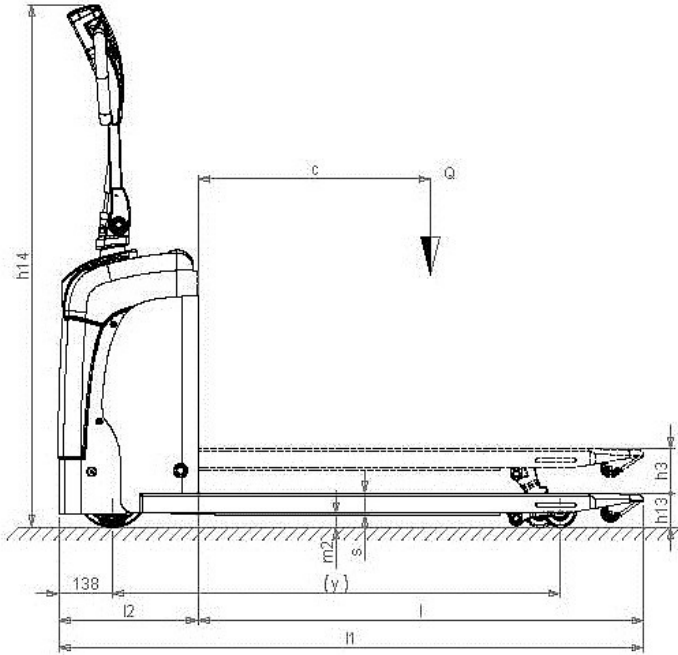

The information is aligned with the Data file at the time of download. Printed on 29/04/2019 (ID 453)

©2019 | PR INDUSTRIAL s.r.l. | All rights reserved | Image shown may not reflect actual package. Specifications subject to change without notice

