

## GS/L PRO 30S4 1220X685

Heavy loads hand pallet truck (3.000 kg)



### LIFTER GS PRO

Extremely tough and resistant hand pallet truck for heavy duty applications, with lifting capacity up to 3.000 kg.



### REINFORCED STRUCTURE

Steel bars welded under the forks, solid tie-rod as well as a base with thick metal sheet allow the GS 30 to easily handle the heaviest loads.



### HYDRAULIC UNIT

Resistant and reliable one piece cast iron pump, worked with numerical control machine, including:

- **MAXIMUM PRESSURE VALVE:** safety device that ensures the transpallet against overloads. When the pressure inside the hydraulic circuit exceeds the set calibration value according to the maximum nominal flow, the valve automatically locks the forks.
- **PROPORTIONAL LOWERING VALVE:** lowering speed can be proportionally controlled according to the lever position on the tiller. Perfect working tool to carry fragile and delicate loads like crystal, glass and ceramics.



### VARNISHING

Following an appropriate conditioning operation the frame is varnished with polyester powder at a temperature of 250° to guarantee maximum resistance to wear and atmospheric agents.

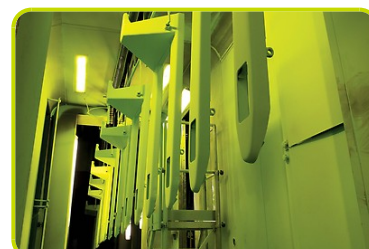

## STANDARD CONFIGURATION

- Nylon - Poly 55 steering wheels
- Nylon rollers
- 4 Curves handle with all the controls (lowering / drive position / lifting) available in a single lever for simple and safe control



- Entry/exit rollers. Supplementary rollers to allow easier entrance and quicker exit from a closed pallet, reducing the impact on the main rollers and guaranteeing a longer life.



## OPTIONAL CONFIGURATION

- Nylon steering wheels
- Aluminium - Poly steering wheels
- Aluminium - Rubber steering wheels



- Polyurethane rollers



- 4 Curves ergonomic handle. The soft rubber covering aids operator comfort and helps to reduce vibration, enabling a more comfortable and secure grip.



- Manual control brake. The brake of the pallet truck, available with rubber steering wheels, is adjustable through the tiller lever to ensure safe use on slopes and ramps. The locking function makes it possible to park the pallet truck even on slopes without rolling away.



- Quick lift. The perfect tool to lift quicker your loads up to 150 kg. The hydraulic pump is specifically engineered to cut job time and increase efficiency. It takes just 6 strokes to raise a pallet to full height, instead of 13 with the traditional HPT.



## Description

1.1 Manufacturer			LIFTER
1.3 Drive			Manual
1.4 Operator type			Pedestrian
1.5 Load capacity	Q	Kg	3000
1.6 Load centre distance	c	mm	610
1.8 Load axle to end forks	x	mm	1002
1.9 Wheel base	y	mm	1262

## Weights

2.1 Service weight		Kg	96
2.2 Axle load, laden rear		Kg	2104
2.2 Axle load, laden front		Kg	992
2.3 Axle load, unladen rear		Kg	32
2.3 Axle load, unladen front		Kg	64

## Tyres/Chassis

3.1 Tyres: front wheels			POLY.I./ NYLON
3.1 Tyres: rear wheels			NYLON
3.2 Tyre size: Steering wheels - Diameter		mm	200
3.2 Tyre size: Steering wheels - Width		mm	55
3.3 Tyre size: Load rollers - Diameter		mm	82
3.3 Tyre size: Load rollers - Width		mm	60
3.5 Tyre size: rear wheels - Q.ty (X=driven)		nr	4
3.5 Rear balancing axle			No
3.6 Tread, front	b10	mm	155
3.7 Tread, rear	b11	mm	535

## Dimensions

4.4 Lift height	h3	mm	115
4.9 Height of tiller in drive position max	h14	mm	1160
4.15 Height, lowered	h13	mm	85
4.19 Overall length	l1	mm	1620
4.20 Length to face of forks	l2	mm	400
4.21 Overall width	b1	mm	685
4.22 Fork dimensions - Thickness	s	mm	50
4.22 Fork dimensions - Width	e	mm	150
4.22 Fork dimensions - Length	l	mm	1220
4.25 Distance between fork arms	b5	mm	685
4.32 Ground clearance, centre of wheelbase	m2	mm	35
4.34 Aisle width	Ast	mm	1855
4.35 Turning radius	Wa	mm	1437

## Performance data

5.2 Lifting speed laden	strokes	13
5.2 Lifting speed unladen	strokes	13

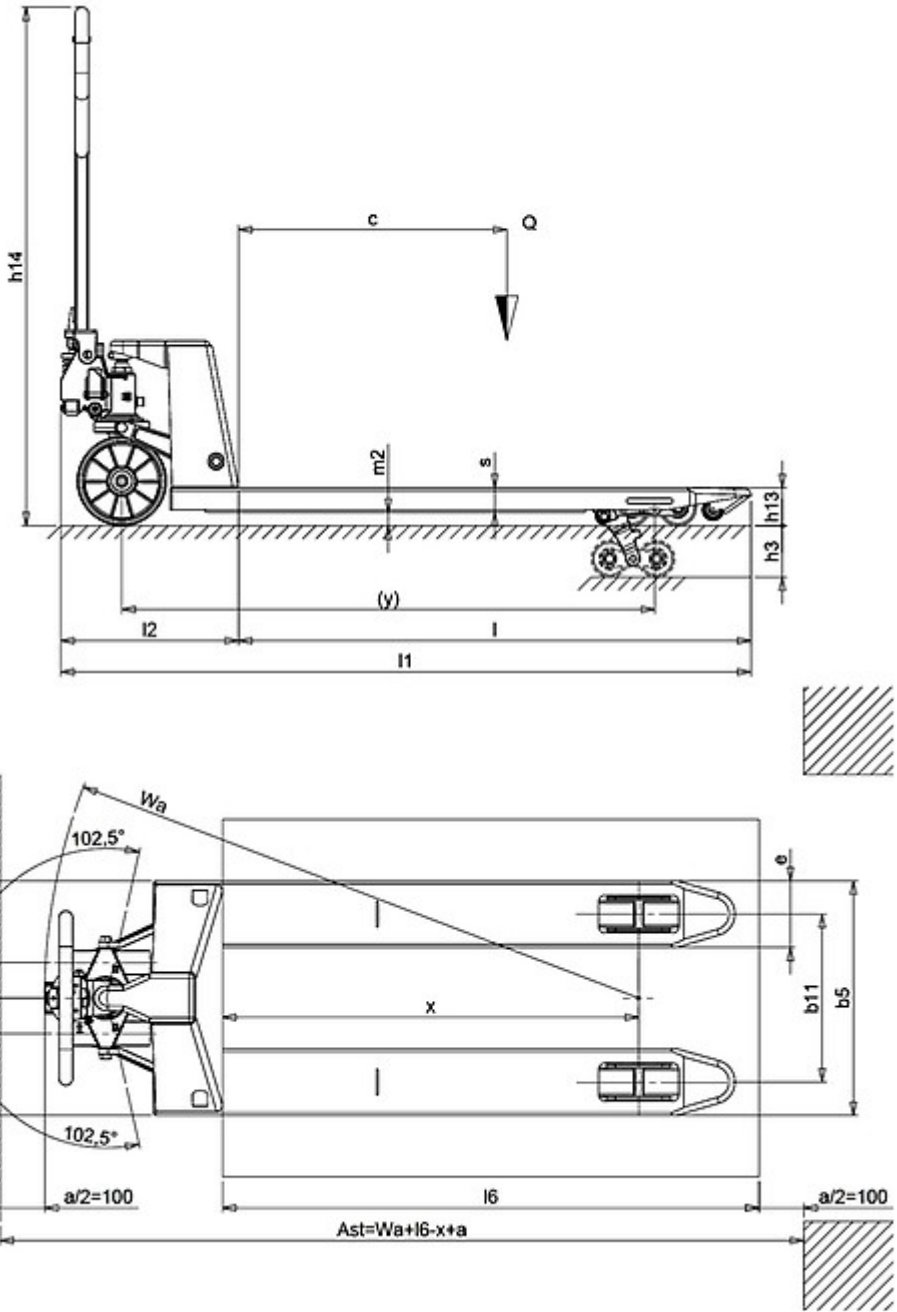

The information is aligned with the Data file at the time of download. Printed on 29/04/2019 (ID 579)

©2019 | PR INDUSTRIAL s.r.l. | All rights reserved | Image shown may not reflect actual package. Specifications subject to change without notice

