

HX10E 1800X540

HIGH LIFT PALLET TRUCK - ELECTRIC



HX10 E

The HX10E scissor Lift makes possible an easy and light lifting to a height of 800 mm thanks to the reliable electric motor and to the powerful battery. When lifted, it becomes a practical work platform, which is suitable for places such as machine workshops. This pallet truck is also able to carry out the support function and material supply along the assembly and production lines.

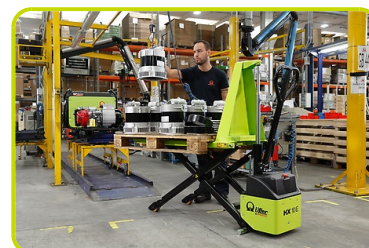

TILLER

The handle offers an ergonomic tiller and an electric switch for lifting and lowering operations. The tiller design ensures operator comfort on pushing operations.



SAFETY AND EFFICIENCY

The emergency pushbutton with the function of battery cut-off switch (isolator) and the off-load valve allowing a smoother lowering of the load are some of the devices that make the work safer and more efficient.



STANDARD CONFIGURATION

Rubber steering wheels and polyurethane rollers

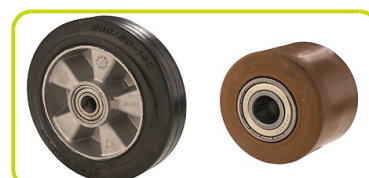

Complete with 12V battery and external battery charger

OPTIONAL CONFIGURATION

AUTO LEVELING SYSTEM

- Automatic system that, by means of a sensor, adjusts the height of the forks keeping constant the desired working height
- Optical and acoustic signal activated at each fork movement
- Possibility of sensor adjustment
- Micro-switch active both on the way up to prevent superfluous absorption of energy and on the way down to protect the operator



PLUS VERSION

- Semi-traction 12V 80Ah C20 battery: powerful battery allowing long endurance and good number of charging cycles
- Battery status indicator



GEL VERSION

- 12V 55Ah C20 battery: particularly suitable for deep cycle applications, gel battery is safer (no acid spilling out) and does not need watering
- Battery status indicator



ON-BOARD BATTERY CHARGER

- Battery status indicator visible from the maneuvering station
- Extendable power charger cable



Description

1.1 Manufacturer			LIFTER
1.3 Drive			Manual
1.4 Operator type			Pedestrian
1.5 Load capacity	Q	Kg	1000
1.6 Load centre distance	c	mm	900
1.8 Load axle to end forks	x	mm	1509
1.9 Wheel base	y	mm	1748

Weights

2.1 Service weight (battery included)		Kg	259
2.2 Axle load, laden rear		Kg	741
2.2 Axle load, laden front		Kg	518
2.3 Axle load, unladen front		Kg	170
2.3 Axle load, unladen rear		Kg	89

Tyres/Chassis

3.1 Tyres: front wheels			RUBBER
3.1 Tyres: rear wheels			POLY.I.
3.2 Tyre size: Steering wheels - Width		mm	50
3.2 Tyre size: Steering wheels - Diameter		mm	200
3.3 Tyre size: Load rollers - Diameter		mm	80
3.3 Tyre size: Load rollers - Width		mm	50
3.5 Tyre size: rear wheels - Q.ty (X=driven)		nr	2
3.6 Tread, front	b10	mm	155
3.7 Tread, rear	b11	mm	447

Dimensions

4.4 Lift height	h3	mm	715
4.9 Height of tiller in drive position max	h14	mm	1300
4.9 Height of tiller in drive position min	h14	mm	915
4.15 Height, lowered	h13	mm	85
4.19 Overall length	l1	mm	2343
4.20 Length to face of forks	l2	mm	540
4.21 Overall width	b1	mm	540
4.22 Fork dimensions - Thickness	s	mm	48
4.22 Fork dimensions - Width	e	mm	160
4.22 Fork dimensions - Length	l	mm	1800
4.25 Distance between fork arms	b5	mm	540
4.32 Ground clearance, centre of wheelbase	m2	mm	21
4.34 Aisle width	Ast	mm	2763
4.35 Turning radius	Wa	mm	2058

Performance data

5.2 Lifting speed laden		m/s	0.08
5.2 Lifting speed unladen		m/s	0.13
5.3 Lowering speed laden		m/s	0.13
5.3 Lowering speed unladen		m/s	0.06

Electric motors

6.2 Lift motor power	kW	1.6
Battery Type	Tipo	AUTOMOTIVE
6.4 Battery voltage	V	12
6.4 Battery capacity, Min	Ah	60
6.4 Battery capacity, Max	Ah	60
6.5 Battery weight, Min	Kg	14
6.5 Battery weight, Max	Kg	14

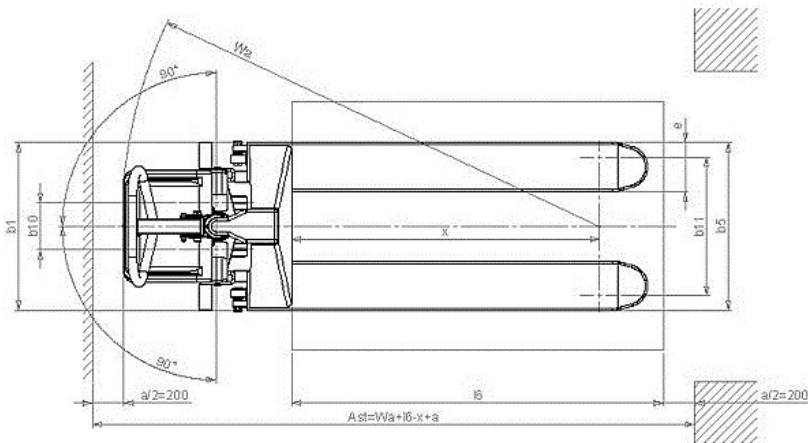
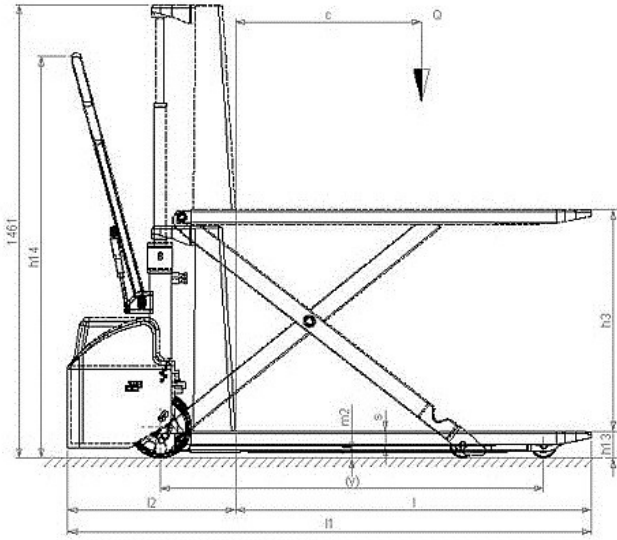

The information is aligned with the Data file at the time of download. Printed on 29/04/2019 (ID 484)

©2019 | PR INDUSTRIAL s.r.l. | All rights reserved | Image shown may not reflect actual package. Specifications subject to change without notice

