

HX10M 1150X540

HIGH LIFT PALLET TRUCK - MANUAL



HX10 M

The HX10M scissor lift makes possible an easy and light lifting to a height of 800 mm, becoming a practical work platform, suitable for places such as machine workshops. This pallet truck is also able to carry out the support function and material supply along the assembly and production lines.



CONTROL LEVER

The handle offers an ergonomic tiller and a 3 positions control lever. The special lowering valve allows you to smoothly lower the load.



HYDRAULIC UNIT

Resistant and reliable one piece cast iron pump including:

- **TWO-STAGE TELESCOPIC LIFTING PISTON:** to allow working with low profile frame granting lightness and better operator visibility.
- **MAXIMUM PRESSURE VALVE:** safety device that ensures the transpallet against overloads. When the pressure inside the hydraulic circuit exceeds the set calibration value according to the maximum nominal flow, the valve automatically locks the forks.
- **PROPORTIONAL LOWERING VALVE:** lowering speed can be proportionally controlled according to the lever position on the tiller. Perfect working tool to carry fragile and delicate loads like crystal, glass and ceramics.



FRONT AND REAR STABILIZERS

The new control linkage makes possible the entry on the closed side of the pallet by a slight lifting, which facilitates the successive handling phases. Furthermore, greater machine stability is achieved by using load rollers in a more advanced position and providing front stabilizers as standard. Work is made even more stable and safer with the rear stabilizers, also when the working height exceeds the 400 mm and in the case of heavy objects.



CONFIGURATION

STANDARD:

Nylon polyurethane steering wheels and polyurethane rollers.

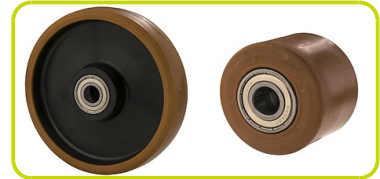

Quick lift. The perfect tool to lift quicker your loads up to 150 kg. The hydraulic pump is specifically engineered to cut by half the job time and increase efficiency.



OPTIONAL:

Rubber steering wheels



Description

1.1 Manufacturer			LIFTER
1.3 Drive			Manual
1.4 Operator type			Pedestrian
1.5 Load capacity	Q	Kg	1000
1.6 Load centre distance	c	mm	600
1.8 Load axle to end forks	x	mm	993
1.9 Wheel base	y	mm	1231

Weights

2.1 Service weight (battery included)		Kg	104
2.2 Axle load, laden rear		Kg	713
2.2 Axle load, laden front		Kg	391
2.3 Axle load, unladen front		Kg	71
2.3 Axle load, unladen rear		Kg	33

Tyres/Chassis

3.1 Tyres: front wheels			POLY.I./ NYLON
3.1 Tyres: rear wheels			POLY.I.
3.2 Tyre size: Steering wheels - Width		mm	45
3.2 Tyre size: Steering wheels - Diameter		mm	200
3.3 Tyre size: Load rollers - Diameter		mm	80
3.3 Tyre size: Load rollers - Width		mm	50
3.5 Tyre size: rear wheels - Q.ty (X=driven)		nr	2
3.6 Tread, front	b10	mm	155
3.7 Tread, rear	b11	mm	447

Dimensions

4.4 Lift height	h3	mm	715
4.9 Height of tiller in drive position max	h14	mm	1250
4.9 Height of tiller in drive position min	h14	mm	415
4.15 Height, lowered	h13	mm	85
4.19 Overall length	l1	mm	1526
4.20 Length to face of forks	l2	mm	376
4.21 Overall width	b1	mm	540
4.22 Fork dimensions - Thickness	s	mm	48
4.22 Fork dimensions - Width	e	mm	160
4.22 Fork dimensions - Length	l	mm	1150
4.25 Distance between fork arms	b5	mm	540
4.32 Ground clearance, centre of wheelbase	m2	mm	21
4.34 Aisle width	Ast	mm	2019
4.35 Turning radius	Wa	mm	1369

Performance data

5.2 Lifting speed laden		m/s	62
5.2 Lifting speed unladen		m/s	30
5.3 Lowering speed laden		m/s	0.06
5.3 Lowering speed unladen		m/s	0.04

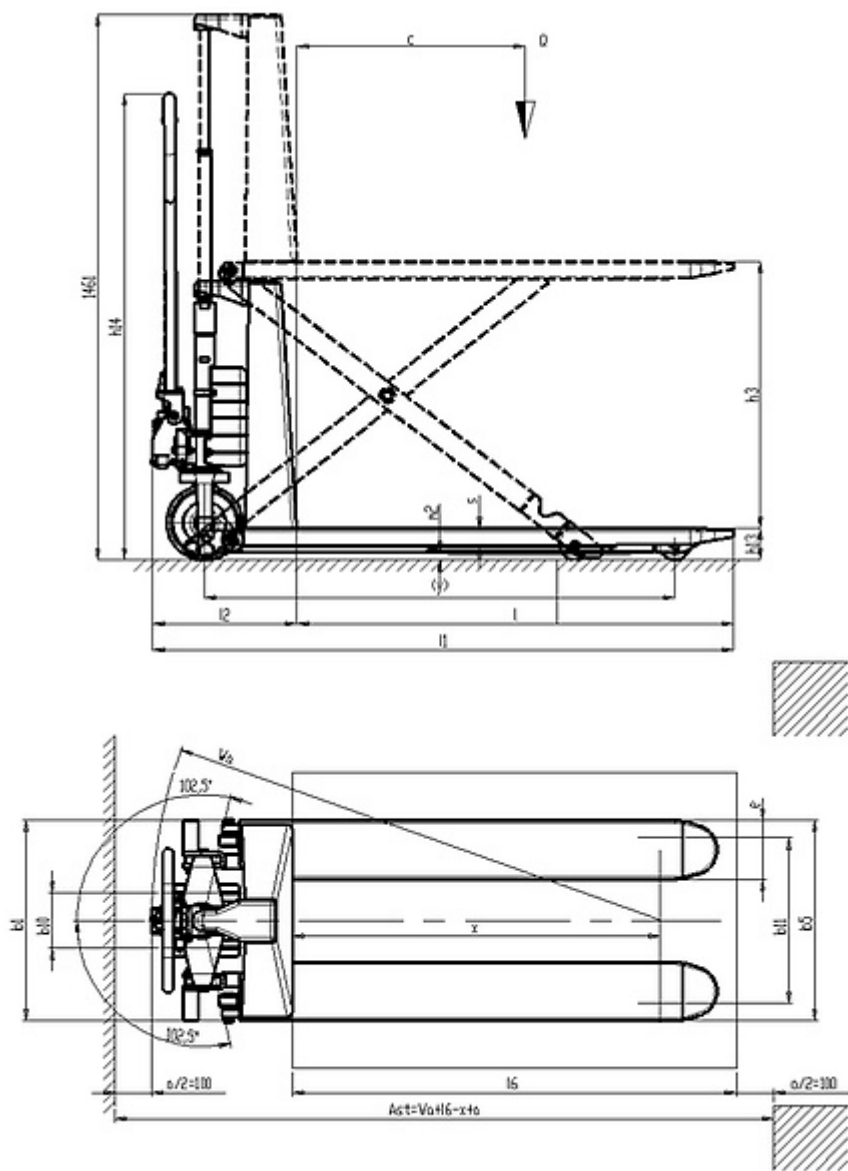

The information is aligned with the Data file at the time of download. Printed on 29/04/2019 (ID 626)

©2019 | PR INDUSTRIAL s.r.l. | All rights reserved | Image shown may not reflect actual package. Specifications subject to change without notice

